

PALOMA SMART - MODEL: TL58S

Motorized Track Light

WAC

PROJECT :

TYPE :

Product Image



Line Drawing

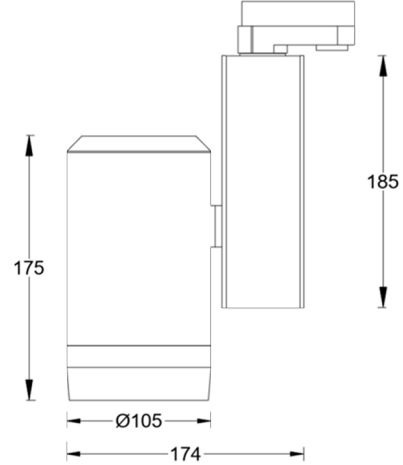

Product Description

The PALOMA PRO smart remote-controlled track light series features a sophisticated design that carefully combines advanced motor and wireless technologies to provide efficient lighting solutions while offering users a diverse lighting experience. Users can choose individual or multiple lights from the app interface or customize various scenes, bringing great flexibility to architectural and technical lighting. It is also compatible with the WAC three-circuit track system.

Product Features

- Body Material: Aluminum alloy die-casting
- Optical System: Lens
- Finish: Static electricity powder coating
- Projection direction: Horizontal adjustment range: 0° to 355°; Vertical adjustment range: 0° to 90°
- Accessories: Remote control (must be ordered separately and can control up to 10 lights simultaneously)
- IP Rating: IP20
- Insulation Level: Class I
- Operating Temperature: -20°C~40°C

Product Specifications

- Beam angle: 12°, 24°, 36°
- LED Type: COB
- LED Power: 20W, 30W or 40W
- Source Lm: 2700K:2255lm(20W) / 3270lm(30W) / 4090lm(40W) 3000K:2390lm(20W) / 3470lm(30W) / 4340lm(40W) 4000K:2610lm(20W) / 3790lm(30W) / 4740lm(40W)
- LED Lifetime: >50000h-L70 / B10-Ta25°C(LM-80/TM-21)
- CCT/CRI: 2700K/3000K/4000K , Ra90
- SDCM: 3 SDCM
- Input: 220V~240V AC / 50Hz
- Dimming: APP/ Remote control (0-10V /DMX512)
- Net Weight: 2.68Kg without packing

Order Model

Model	LED	Dimming	Beam	CRI	CCT	Finish
TL58S PALOMA Smart	LM20 COB 20W	B APP	1 12°	9 90	27 2700K	WT White BK Black
	LM30 COB 30W	G Remote control	2 24°		30 3000K	
	LM40 COB 40W	D Remote control +0-10V M Remote control +DMX512	3 36°		40 4000K	
TL58S	LM20	G	2	9	30	WT

Example : TL58SLM20-G-2930WT

PALOMA SMART - MODEL: TL58S







Motorized Track Light



PROJECT :

TYPE :

Accessories

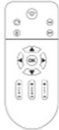
Class 1 Accessories	LENS-25-BEL-SW striped glass 	LENS-25-BSL soft light glass lens 	LENS-25-FR-SW Matte glass lens 	LENS-25-LCM-SW Edgeless Bee Mesh 
Class 2 Accessories	LENS-25-SNOOT-SW Anti-glare cylinder 	LENS-25P-CRL-BK Anti-glare plastic cross grid 	LENS-25-HCL Anti-glare bee mesh grille 	
remote control	PAD-TL58S-WT Handheld Remote Controller 			

Note: Each type of accessory can only be installed at most one at a time, and they all need to be ordered separately.

LIGHT DISTRIBUTION@3000K LUMINAIRE DATA

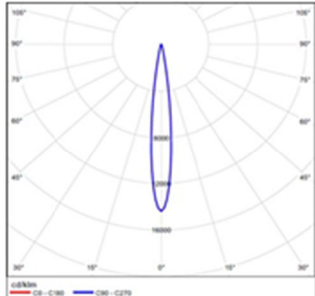
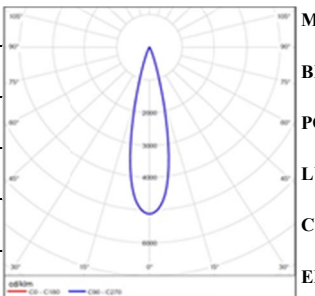
	MODEL : TL58SLM20-G-1930		MODEL : T L58SLM20-G-2930
	BEAM ANGLE : 12°		BEAM ANGLE : 24°
	POWER : 24W		POWER : 24W
	LUMENS : 1925lm		LUMENS : 2118lm
	CBCP : 27692cd		CBCP : 10831cd
	EFFICACY : 80lm /W		EFFICACY : 88lm /W

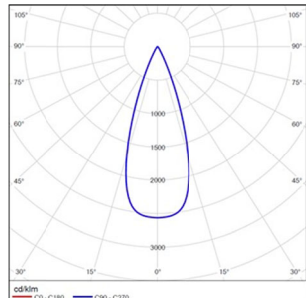
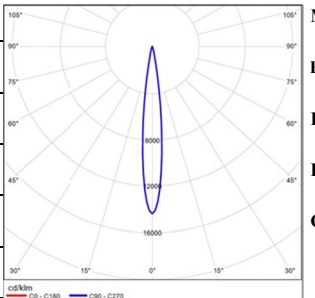
	MODEL : TL58SLM20-G-3930		MODEL : TL58SLM30-G-1930
	BEAM ANGLE : 36°		BEAM ANGLE : 12°
	POWER : 24W		POWER : 34W
	LUMENS : 2237lm		LUMENS : 2664lm
	CBCP : 5737cd		CBCP : 38323cd
	EFFICACY : 93lm/W		EFFICACY : 78lm/W

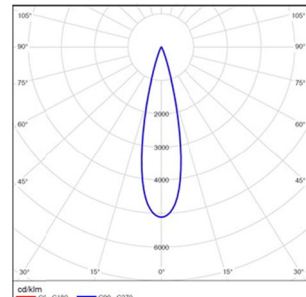
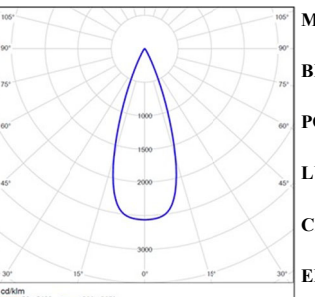
	MODEL : TL58SLM30-G-2930		MODEL : TL58SLM30-G-3930
	BEAM ANGLE : 24°		BEAM ANGLE : 36°
	POWER : 34W		POWER : 34W
	LUMENS : 2931lm		LUMENS : 3085lm
	CBCP : 14988cd		CBCP : 7912cd
	EFFICACY : 86lm/W		EFFICACY : 91lm/W

PALOMA SMART - MODEL: TL58S

Motorized Track Light

WAC

PROJECT :

TYPE :

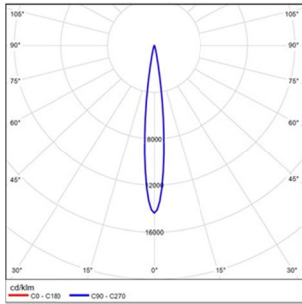

MODEL : TL58SLM40-G-1930

BEAM ANGLE : 12°

POWER : 45W

LUMENS : 3546lm

CBCP : 51011cd

EFFICACY : 79lm/W

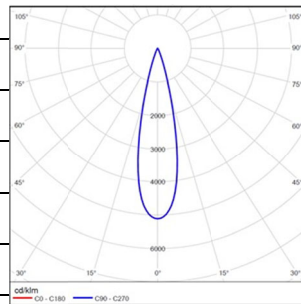

MODEL : TL58SLM40-G-2930

BEAM ANGLE : 24°

POWER : 45W

LUMENS : 3755lm

CBCP : 19202cd

EFFICACY : 83lm/W

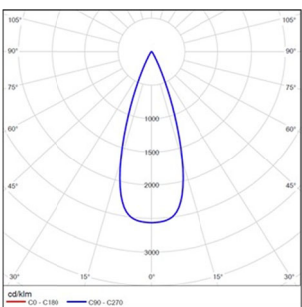

MODEL : TL58SLM40-G-3930

BEAM ANGLE : 36°

POWER : 45W

LUMENS : 3922lm

CBCP : 10058cd

EFFICACY : 87lm/W