

**VOLTA - MODEL: DDT21**  
2" Round Recessed Adjustable Downlight

**WAC**

PROJECT:

TYPE:

**Product Image**



**Line Drawing**

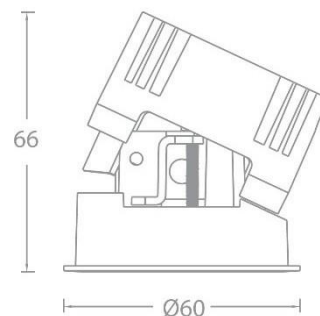

**Product Description**

VOLTA series LED round narrow-edge recessed angle downlights have a streamlined appearance and adopt precise lens and black mirror reflector designs to ensure that the light is emitted while still achieving the ultimate anti-glare effect. The light source cavity adopts a sealed design, which can minimize the impact of humid environment on its performance, and the reflector or optical accessories can be freely disassembled and replaced, which greatly improves on-site convenience and is mainly suitable for hotels and commercial indoor places.

**Product Features**

- Body Material: Aluminum alloy die-casting
- Optical System: Lens+ SUBOROSA optical system
- Finish: Static electricity powder coating
- Adjustable Angle: 0-25 °tilt
- Accessories: As attached
- Certification: CCC
- IP Rating: IP20(Light source cavity IP44)
- Insulation Level: Class II
- Operating Temperature: -20°C~40°C

**Product Specifications**

- Cut-out: Ø55mm
- Ceiling Thickness: 1mm~15mm
- Shielding Angle: 30 °
- LED Type: HP LED
- Source Lm: 2700K: 682 lm;3000K: 720 lm;3500K: 752 lm; 4000K: 765 lm;5000K: 774 lm
- LED Lifetime: >50000h-L70 /B10-Ta25°C(LM-80/TM-21)
- CCT/CRI: 2700K/3000K/3500K/4000K/5000K, Ra90
- Input: 220V AC / 50Hz
- Dimming: ON-OFF / 0-10V /DALI
- Net Weight: 0.2Kg without packing

**Order Model**

Model	Size	Trim	LED	Driver	Beam	CCT	Reflector	Finish
<b>DDT</b> Downlight Directional T series	2 2"	1 Round Trim	<b>LD08</b> LED 8W	<b>E</b> ON-OFF	1 15 °	<b>27</b> 2700K	<b>B</b> Black <b>S</b> Specular	<b>WT</b> White <b>BK</b> Black
				<b>D</b> 0-10V	2 24 °	<b>30</b> 3000K		
				<b>N</b> NO DRIVER	3 36 °	<b>35</b> 3500K		
				<b>A</b> DALI	5 50 °	<b>40</b> 4000K		
						<b>50</b> 5000K		

Example: DDT21-LD08E-230SWT



**VOLTA - MODEL: DDT21**  
**2" Round Recessed Adjustable Downlight**



PROJECT:

TYPE:

**Accessories**

<b>LENS-DLT21-BEL</b> Striped glass lens 	<b>LENS-DLT21-HCL</b> Honeycomb 
---	--

Note: A maximum of one optical accessory can be installed. The accessories are not shipped from the factory and need to be ordered separately.

**LIGHT DISTRIBUTION@3000K LUMINAIRE DATA**

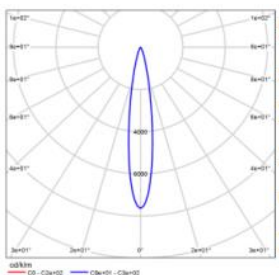

**MODEL:** DDT21-LD08E-130SWT  
**BEAM ANGLE:** 15 °  
**POWER:** 10W  
**LUMENS:** 397lm  
**CBCP:** 2992cd  
**EFFICACY:** 40lm/W

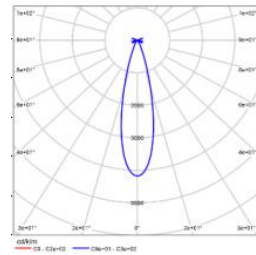

**MODEL:** DDT21-LD08E-230SWT  
**BEAM ANGLE:** 24 °  
**POWER:** 10W  
**LUMENS:** 455lm  
**CBCP:** 1795cd  
**EFFICACY:** 46lm/W

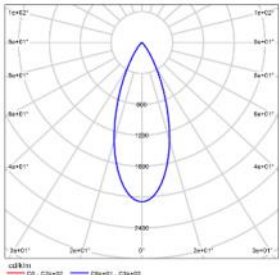

**MODEL:** DDT21-LD08E-330SWT  
**BEAM ANGLE:** 36 °  
**POWER:** 10W  
**LUMENS:** 445lm  
**CBCP:** 1005cd  
**EFFICACY:** 45lm/W

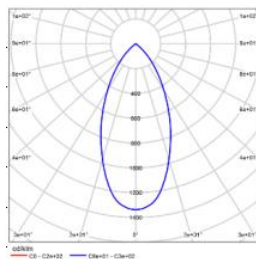

**MODEL:** DDT21-LD08E-530SWT  
**BEAM ANGLE:** 50 °  
**POWER:** 10W  
**LUMENS:** 302lm  
**CBCP:** 426cd  
**EFFICACY:** 30lm/W

**VOLTA - MODEL: DDT31**  
3" Round Recessed Adjustable Downlight



PROJECT:

TYPE:

**Product Image**



**Line Drawing**

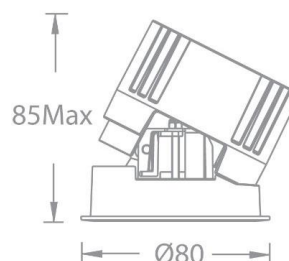

**Product Description**

VOLTA series LED round narrow-edge recessed angle downlights have a streamlined appearance and adopt precise lens and black mirror reflector designs to ensure that the light is emitted while still achieving the ultimate anti-glare effect. The light source cavity adopts a sealed design, which can minimize the impact of humid environment on its performance, and the reflector or optical accessories can be freely disassembled and replaced, which greatly improves on-site convenience and is mainly suitable for hotels and commercial indoor places.

**Product Features**

- Body Material: Aluminum alloy die-casting
- Optical System: Lens+ SUBOROSA optical system
- Finish: Static electricity powder coating
- Adjustable Angle: 0-25 ° tilt
- Accessories: As attached
- Certification: CCC
- IP Rating: IP20(Light source cavity IP44)
- Insulation Level: Class II
- Operating Temperature: -20°C~40°C

**Product Specifications**

- Cut-out: Ø75mm
- Ceiling Thickness: 1mm~15mm
- Shielding Angle: 30 °
- LED Type: COB
- Source Lm:
  - 2700K: 8W 682lm; 7W 758lm; 10W 1080lm; 13W 1404lm
  - 3000K: 8W 720lm; 7W 800lm; 10W 1150lm; 13W 1495lm
  - 3500K: 8W 752lm; 7W 835lm; 10W 1195lm; 13W 1554lm
  - 4000K: 8W 765lm; 7W 850lm; 10W 1210lm; 13W 1573lm
  - 5000K: 8W 774lm; 7W 860lm; 10W 1220lm; 13W 1586lm
- LED Lifetime: >50000h-L70 /B10-Ta25°C(LM-80/TM-21)
- CCT/CRI: 2700K/3000K/3500K/4000K/5000K, Ra90
- Input: 220V AC / 50Hz
- Dimming: ON-OFF / 0-10V /DALI
- Net Weight: 0.35Kg without packing

**Order Model**

Model	Size	Trim	LED	Driver	Beam	CCT	Reflector	Finish
<b>DDT</b> Downlight Directional T series	3 3"	1 Round Trim	LM08 LED 8W	E ON-OFF D 0-10V	S 8°	27 2700K	B Black S Specular	WT White BK Black
			LM07 COB 7W		1 15°	30 3000K		
			LM10 COB 10W		2 24°	35 3500K		
			LM13 COB 13W		3 36°	40 4000K		
			LM13 COB 13W	5 50°	50 5000K			
				N NO DRIVER A DALI				

Example: DDT31-LM13E-230SWT

# VOLTA - MODEL: DDT31



## 3" Round Recessed Adjustable Downlight



PROJECT:

TYPE:

### Accessories

<b>LENS-DLT31-BEL</b> Striped glass lens 	<b>LENS-DLT31-HCL</b> Honeycomb 
--	---

Note: A maximum of one optical accessory can be installed. The accessories are not shipped from the factory and need to be ordered separately.

### LIGHT DISTRIBUTION@3000K LUMINAIRE DATA

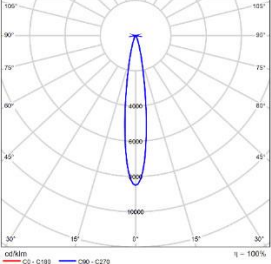
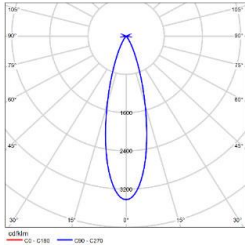
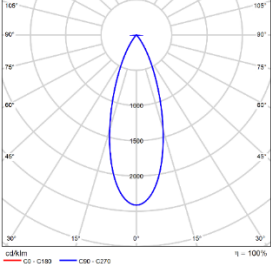
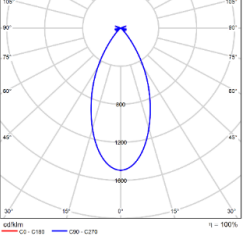
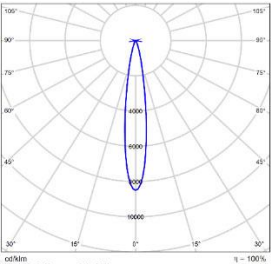
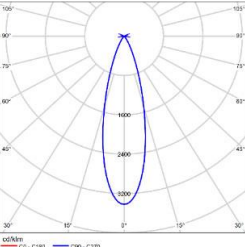
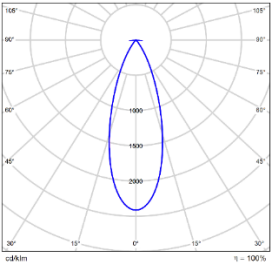
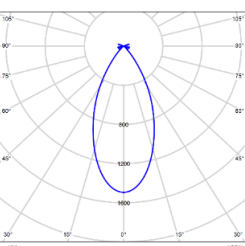
	<b>MODEL:</b> DDT31-LM07E-130SWT <b>BEAM ANGLE:</b> 15° <b>POWER:</b> 8W <b>LUMENS:</b> 438lm <b>CBCP:</b> 3725cd <b>EFFICACY:</b> 55lm/W		<b>MODEL:</b> DDT31-LM07E-230SWT <b>BEAM ANGLE:</b> 24° <b>POWER:</b> 8W <b>LUMENS:</b> 554lm <b>CBCP:</b> 1894cd <b>EFFICACY:</b> 69lm/W
	<b>MODEL:</b> DDT31-LM07E-330SWT <b>BEAM ANGLE:</b> 36° <b>POWER:</b> 8W <b>LUMENS:</b> 456lm <b>CBCP:</b> 1001cd <b>EFFICACY:</b> 57lm/W		<b>MODEL:</b> DDT31-LM07E-530SWT <b>BEAM ANGLE:</b> 50° <b>POWER:</b> 8W <b>LUMENS:</b> 378lm <b>CBCP:</b> 565cd <b>EFFICACY:</b> 47lm/W
	<b>MODEL:</b> DDT31-LM10E-130SWT <b>BEAM ANGLE:</b> 15° <b>POWER:</b> 11W <b>LUMENS:</b> 542lm <b>CBCP:</b> 4604cd <b>EFFICACY:</b> 49lm/W		<b>MODEL:</b> DDT31-LM10E-230SWT <b>BEAM ANGLE:</b> 24° <b>POWER:</b> 11W <b>LUMENS:</b> 685lm <b>CBCP:</b> 2341cd <b>EFFICACY:</b> 62lm/W
	<b>MODEL:</b> DDT31-LM10E-330SWT <b>BEAM ANGLE:</b> 36° <b>POWER:</b> 11W <b>LUMENS:</b> 564lm <b>CBCP:</b> 1361cd <b>EFFICACY:</b> 51lm/W		<b>MODEL:</b> DDT31-LM10E-530SWT <b>BEAM ANGLE:</b> 50° <b>POWER:</b> 11W <b>LUMENS:</b> 467lm <b>CBCP:</b> 698cd <b>EFFICACY:</b> 42lm/W

**VOLTA - MODEL: DDT31**  
**3" Round Recessed Adjustable Downlight**



PROJECT:

TYPE:

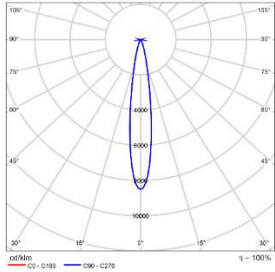

**MODEL:** DDT31-LM13E-130SWT  
**BEAM ANGLE:** 15 °  
**POWER:** 15W  
**LUMENS:** 710lm  
**CBCP:** 6027cd  
**EFFICACY:** 47lm/W

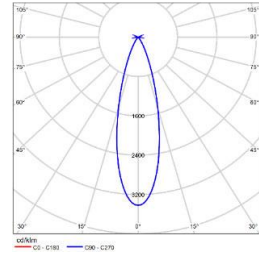

**MODEL:** DDT31-LM13E-230SWT  
**BEAM ANGLE:** 24 °  
**POWER:** 15W  
**LUMENS:** 896lm  
**CBCP:** 3065cd  
**EFFICACY:** 60lm/W

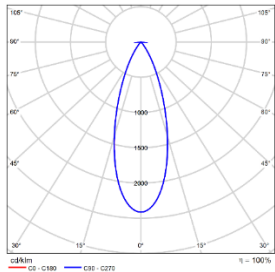

**MODEL:** DDT31-LM13E-330SWT  
**BEAM ANGLE:** 36 °  
**POWER:** 15W  
**LUMENS:** 738lm  
**CBCP:** 1782cd  
**EFFICACY:** 49lm/W

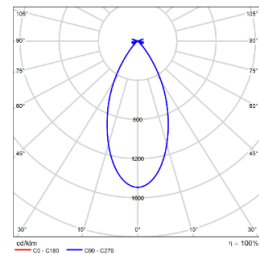

**MODEL:** DDT31-LM13E-530SWT  
**BEAM ANGLE:** 50 °  
**POWER:** 15W  
**LUMENS:** 612lm  
**CBCP:** 914cd  
**EFFICACY:** 41lm/W

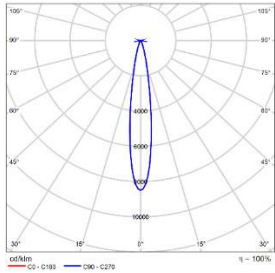

**MODEL:** DDT31-LD08E-S30SWT  
**BEAM ANGLE:** 8 °  
**POWER:** 11W  
**LUMENS:** 375lm  
**CBCP:** 9280cd  
**EFFICACY:** 34lm/W