

VOLTA - MODEL: DLT01

Recessed Ceiling Luminaires

WAC LIGHTING
Responsible Lighting®

PROJECT:

TYPE:

Product Image



Line Drawing

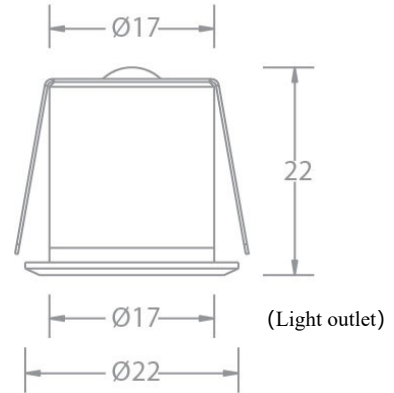

DESCRIPTION

The VOLTA series mini down lighting tube lamp has a simple appearance and exquisite dimensions; Using a lens for light distribution, it has a precise light angle and an ultimate anti glare effect. Can be applied to hotels, commercial public spaces, and other places.

Product Features

- Body Material: Aluminum alloy die-casting
- Optical System: Lens
- Finish: Static electricity powder coating
- Adjustable Angle: /
- Accessories: Equipped with honeycomb (17°、24°、36°)
- Certification: CCC
- IP Rating: IP20
- Insulation Level: Class II
- Operating Temperature: -20°C~40°C

Product Specifications

- Cut-out: Ø18mm
- Ceiling Thickness: 1mm~15mm
- Shielding Angle: 15°
- LED Type: HP LED
- Source Lm: 3000K 100lm; 4000K 110lm;
- LED Lifetime: >50000h-L70 /B10-Ta25°C(LM-80/TM-21)
- CCT/CRI: 2700K/ 3000K/3500K/4000K, Ra90
- SDCM: 3 SDCM
- Input: 24V DC
- Dimming: DMX512(24V)
- Net Weight: 0.01Kg , without packing

Ordering Model

Model	Size	Trim	LED	Driver	Beam	CCT	Reflector	Finish
DLT Downlight Directional T series	0 0.5"	1 Round Trim	LD01 LED 1W	T DMX512(24VDC)	1 17°	27 2700K	W White	WT White
				M MTB *	2 24°	30 3000K		
				N No Driver	3 36°	35 3500K	B Black	BK Black
					6 60°	40 4000K		

Example: DLT01-LD01N-230WWT

Note: Except for 60°, all other products come with their own honeycomb when leaving the factory. MTB needs to be ordered separately and cannot be directly connected to the mains. (MTB: <https://www.waclighting.com.cn/product-detail/300>)

Accessory

/

WAC Lighting
www.waclighting.com (US)
www.waclighting.com.cn (China)

Headquarters
44 Harbor Park Drive • Port Washington, NY
Phone (516) 515.5000 • Fax (516) 515.5050

WAC Lighting Technology (Shanghai) Co, Ltd.
14, Lane 299, Bi Sheng Road, Shanghai 201204
Phone (86.21) 3393.3558 • Fax (86.21) 3362.1598

VOLTA - MODEL: DDT11

1-inch narrow edge embedded downward light with adjustable angle tube lamp

WAC LIGHTING

Responsible Lighting®

PROJECT:

TYPE:

LIGHT DISTRIBUTION@3000K LUMINAIRE DATA

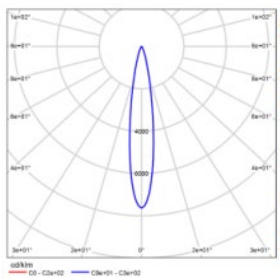

MODEL:	DLT01-LD01T-130WWT
BEAM ANGLE:	17°
POWER:	1.5W
LUMENS:	41lm
CBCP:	271cd
EFFICACY:	27lm/W

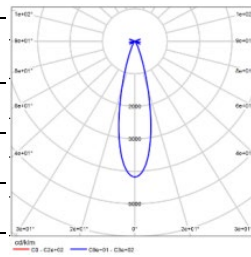

MODEL:	DLT01-LD01T-230WWT
BEAM ANGLE:	24°
POWER:	1.5W
LUMENS:	455lm
CBCP:	178cd
EFFICACY:	25lm/W

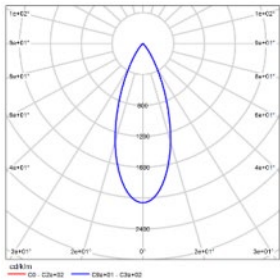

MODEL:	DLT01-LD01T-330WWT
BEAM ANGLE:	36°
POWER:	1.5W
LUMENS:	27lm
CBCP:	53cd
EFFICACY:	18lm/W

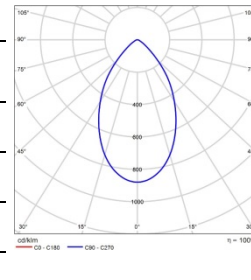

MODEL:	DLT01-LD01T-630WWT
BEAM ANGLE:	60°
POWER:	1.5W
LUMENS:	63lm
CBCP:	55cd
EFFICACY:	42lm/W

VOLTA - MODEL: DDT11

1-inch narrow edge embedded downward light with adjustable angle tube lamp

WAC LIGHTING

Responsible Lighting®

PROJECT:

TYPE:

Product Image



Line Drawing

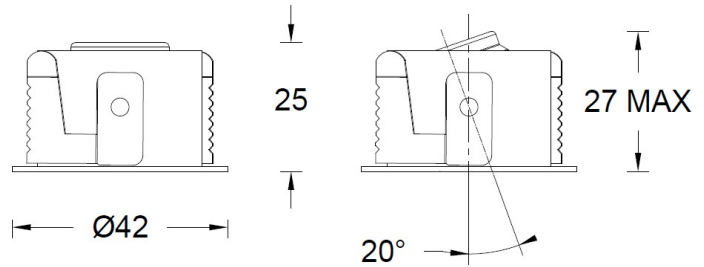

DESCRIPTION

The VOLTA series LED circular narrow edge embedded tube light has a simple appearance and exquisite size, which can be used for lighting or angle adjustment. Adopting a lens+honeycomb light distribution, it has a precise light angle and an ultimate anti glare effect. Can be applied to hotels, commercial public spaces, and other places.

Product Features

- Body Material: Aluminum alloy die-casting
- Optical System: Lens
- Finish: Static electricity powder coating
- Adjustable Angle: Horizontal 0~360°, vertical -20°~20°
- Accessories: Equipped with honeycomb
- Certification: CCC
- IP Rating: IP20
- Insulation Level: Class II
- Operating Temperature: -20°C~40°C

Product Specifications

- Cut-out: Ø36mm
- Ceiling Thickness: 1mm~15mm
- Shielding Angle: 15°
- LED Type: HP LED
- Source Lm: 2700K 170lm; 3000K 175lm; 4000K 185lm;
- LED Lifetime: >50000h-L70/B10-Ta25°C(LM-80/TM-21)
- CCT/CRI: 2700K/3000K/4000K, Ra90
- SDCM: 3 SDCM
- Input: 220V-240V AC /50Hz
- Dimming: /
- Net Weight: 0.1Kg, without packing

Ordering Model

Model	Size	Trim	LED	Driver	Beam	CCT	Reflector	Finish
DDT Downlight Directional T series	1 1"	1 Round Trim	LD02 LED 2W	E On-Off N No Driver	1 12°	27 2700K	W White	WT White
					2 24°	30 3000K		
					3 36°	35 3500K	B Black	BK Black
					5 55°	40 4000K		

Example: DDP11-LD02E-230WWT

WAC Lighting
www.waclighting.com (US)
www.waclighting.com.cn (China)

Headquarters
44 Harbor Park Drive • Port Washington, NY
Phone (516) 515.5000 • Fax (516) 515.5050

WAC Lighting Technology (Shanghai) Co, Ltd.
14, Lane 299, Bi Sheng Road, Shanghai 201204
Phone (86.21) 3393.3558 • Fax (86.21) 3362.1598

VOLTA - MODEL: DDT11

1-inch narrow edge embedded downward light with adjustable angle tube lamp

WAC LIGHTING

Responsible Lighting®

PROJECT:

TYPE:

Accessory

/

LIGHT DISTRIBUTION@3000K LUMINAIRE DATA

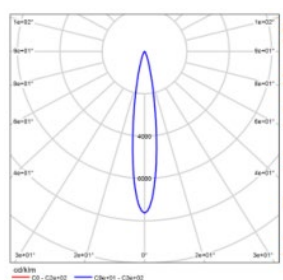

MODEL: DDT11-LD02E-130WWT
BEAM ANGLE: 12°
POWER: 4W
LUMENS: 91lm
CBCP: 1122cd
EFFICACY: 23lm/W

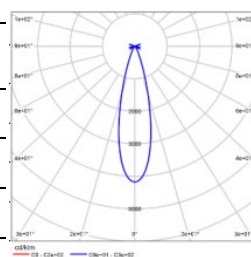

MODEL: DDT11-LD02E-230WWT
BEAM ANGLE: 24°
POWER: 4W
LUMENS: 95lm
CBCP: 390cd
EFFICACY: 24lm/W

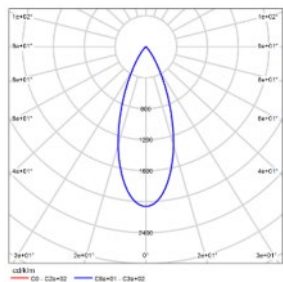

MODEL: DDT11-LD02E-330WWT
BEAM ANGLE: 36°
POWER: 4W
LUMENS: 89lm
CBCP: 211cd
EFFICACY: 22lm/W

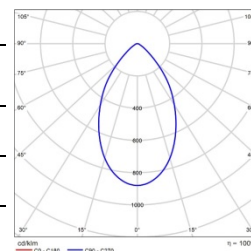

MODEL: DDT11-LD02E-530WWT
BEAM ANGLE: 55°
POWER: 4W
LUMENS: 74lm
CBCP: 88cd
EFFICACY: 19lm/W

VOLTA- MODEL: DDT11

1-inch circular narrow edge embedded downward light with adjustable angle

WAC LIGHTING

Responsible Lighting®

PROJECT:

TYPE:

Product Image



Line Drawing

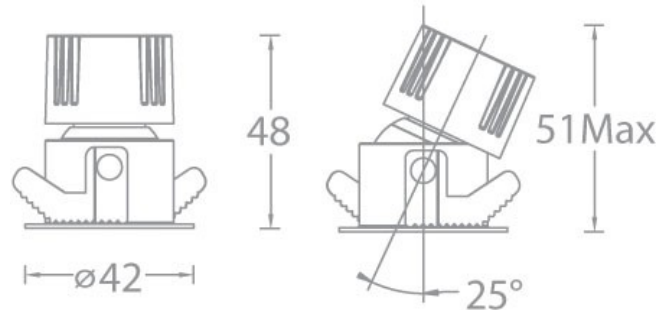

DESCRIPTION

The VOLTA series LED circular narrow edge embedded tube light has a simple appearance and exquisite size, which can be used for lighting or angle adjustment. Adopting a lens+honeycomb light distribution, it has a precise light angle and an ultimate anti glare effect. Can be applied to hotels, commercial public spaces, and other places.

Product Features

- Body Material: Aluminum alloy die-casting
- Optical System: Lens+ honeycomb
- Finish: Static electricity powder coating
- Adjustable Angle: Vertical 0-25 ° adjustment
- Accessories: Equipped with honeycomb
- Certification: CCC
- IP Rating: IP20
- Insulation Level: Class II
- Operating Temperature: -20°C~40°C

Product Specifications

- Cut-out: Ø36mm
- Ceiling Thickness: 1mm~15mm
- Shielding Angle: 15°
- LED Type: HP LED
- Source Lm: 2700K 474lm; 3000K 500lm; 3500K 522lm; 4000K 531lm; 5000K 538lm; >50000h-L70 /B10-Ta25°C(LM-80/TM-21)
- LED Lifetime: >50000h-L70 /B10-Ta25°C(LM-80/TM-21)
- CCT/CRI: 2700K/ 3000K/3500K/ 4000K/4000K,Ra90
- Input: 220V AC /50Hz
- Dimming: Non dimming/0-10V/DALI (must undergo compatibility testing with the project site system in advance)
- Net Weight: 0.1Kg , without packing

Ordering model

Model	Size	Trim	LED	Driver	Beam	CCT	Reflector	Finish
DDT Downlight Directional T series	1 1"	1 Round Trim	LD05 LED 5W	E On-Off D 0-10V Dimming A DALI N No Driver	1 15° 2 24° 3 36° 5 50°	27 2700K 30 3000K 35 3500K 40 4000K 50 5000K	WT White BK Black	WT White BK Black

Example: DDT11-LD05E-230WWT

WAC Lighting
www.waclighting.com (US)
www.waclighting.com.cn (China)

Headquarters
44 Harbor Park Drive • Port Washington, NY
Phone (516) 515.5000 • Fax (516) 515.5050

WAC Lighting Technology (Shanghai) Co, Ltd.
14,Lane 299, Bi Sheng Road,Shanghai 201204
Phone (86.21) 3393.3558 • Fax (86.21) 3362.1598

VOLTA- MODEL: DDT11

1-inch circular narrow edge embedded downward light with adjustable angle

WAC LIGHTING

Responsible Lighting®

PROJECT:

TYPE:

Accessory

/

LIGHT DISTRIBUTION@3000K LUMINAIRE DATA

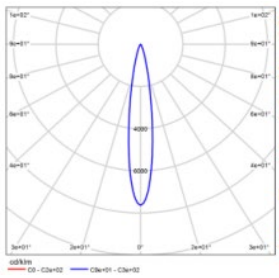

MODEL:	DDT11-LD05E-130SWT
BEAM ANGLE:	15°
POWER:	5.5W
LUMENS:	274lm
CBCP:	2185cd
EFFICACY:	50lm/W

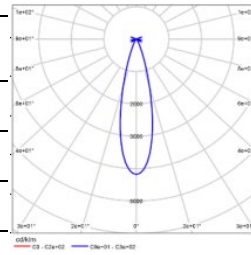

MODEL:	DDT11-LD05E-230SWT
BEAM ANGLE:	24°
POWER:	5.5W
LUMENS:	235lm
CBCP:	914cd
EFFICACY:	43lm/W

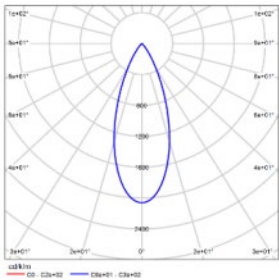

MODEL:	DDT11-LD05E-330SWT
BEAM ANGLE:	36°
POWER:	5.5W
LUMENS:	218lm
CBCP:	477cd
EFFICACY:	40lm/W

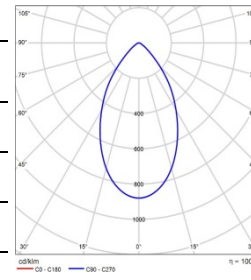

MODEL:	DDT11-LD05E-530SWT
BEAM ANGLE:	50°
POWER:	5.5W
LUMENS:	184lm
CBCP:	281cd
EFFICACY:	33lm/W